

USAGE AREAS:

It is suitable for use in outdoor and indoor sports facilities, concerts and event areas.

SYSTEM DEFINITION:

The next-generation GRAND fixed stadium seat, produced with the gas Inflation system, is a system that can be directly mounted on the riser without the need for metal parts.



FEATURES:

The fixed grandstand seat offers comfortable and practical use with its ergonomic design, lightweight portability, easy assembly, and durability.

GRAND 102

TECHNICAL SPECIFICATIONS

1	The corrosion, which has been the biggest problem for open and closed sports facilities, is now completely preventable. The central shaft in the operating mechanism is made of hardened special alloy aluminum and assembled with aluminum washers and 304-grade stainless steel bolts. This ensures that our product will not experience rusting issues even in water.
2	With various options, a seating height of 45 cm can be achieved at each step, and these options can be easily assembled.
3	With UV and antioxidant additives, color fading and chalkiness have been prevented, and it comes with a 5-year warranty in these aspects.
4	Burning is delayed with FR additive. This feature is certified with the UL 94 - V2 test report.
5	Production is carried out using original polypropylene and special composite raw material additives, inflated by gas injection method. This allows the product to demonstrate top-level performance in terms of impact resistance.
6	The seats are designed to resist breakage and disassembly by hooligans.
7	Automatic closure is achieved without a spring, thanks to the weight center.
8	The front of the seating area is designed in an oval shape that does not disturb the legs.
9	The backrest is produced in a curved and ergonomic structure.
10	When closed, there is a visible seat number area.
11	To fix the seats to the step, the step forehead is drilled at four points. After cleaning the holes, a steel dowel is placed, and then the product is attached to the step using an M8 chrome bolt. This prevents the rusting of assembly elements.

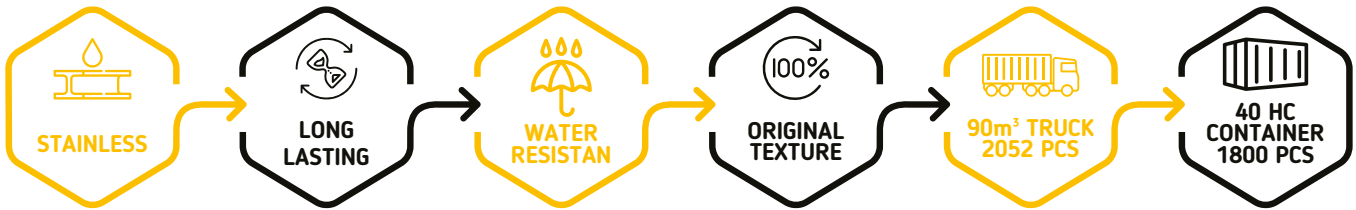

PRODUCT IMAGES



COLOURS

Standard Ral Codes

RAL 3028	RAL 5002	RAL 6029
RAL 1018	RAL 9005	RAL 9010

TECHNICAL DRAWING

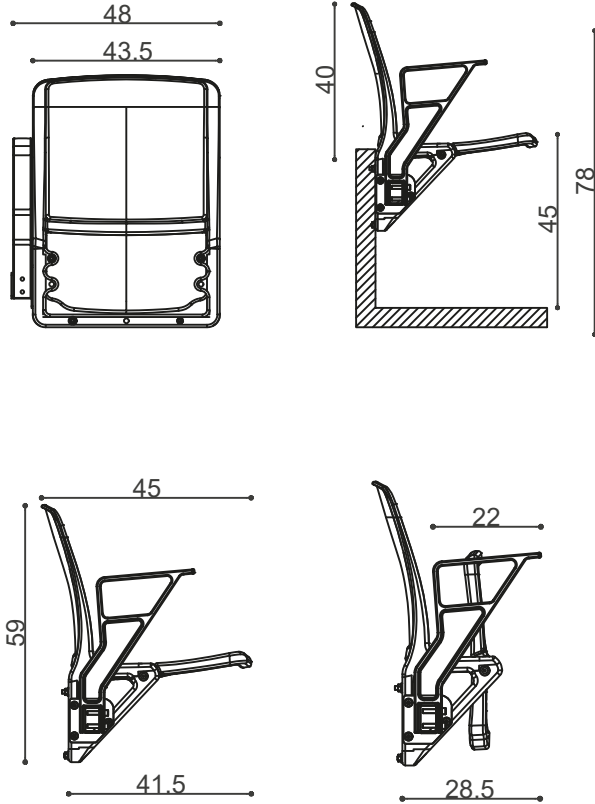

PHOTOS FROM PRODUCTION



GRAND 102

APPLICATION AREAS



stila[®]
Design & Build